



Compact slide cylinder(Recirculating linear ball bearing)——HLQ Series

Compendium of HLQ\HLQL Series

Multi-adjuster option

Recirculating linear ball bearing
Recirculating linear ball bearing, it achieves high precision, high rigidity, with antirust and dustproof function.

Mounting cylinder from 3 directions
Through hole for body mounting. Body mounting holes provide 3 mounting positions. Pin holes for positioning.

Dual rod structure
Dual rod-doubles the output thrust

Floating joint design
Piston rod needn't endure additional torque

Mounting workpiece from 2 directions

With magnetic switch slots
There are magnetic switch slots side of the cylinder body convenient to install inducting switch.

Two models (HLQ/HLQL) are available
Standard: HLQ
Symmetrical: HLQL

Six bore size are available
Bore size: 6, 8, 12, 16, 20, 25

Criteria for selection: Cylinder thrust

Unit: Newton(N)

Bore size	Rod size	Acting type	Pressure area(mm ²)	Operating pressure(MPa)						
				0.2	0.3	0.4	0.5	0.6	0.7	
6	3	Double acting	Push-side	42	8	13	17	21	25	29
			Pull-side	57	11	17	23	29	34	40
8	4	Double acting	Push-side	75	15	23	30	38	45	53
			Pull-side	101	20	30	40	51	61	71
12	6	Double acting	Push-side	170	34	51	68	85	102	119
			Pull-side	226	45	68	90	113	136	158
16	8	Double acting	Push-side	302	60	91	121	151	181	211
			Pull-side	402	80	121	161	201	241	281
20	10	Double acting	Push-side	471	94	141	188	236	283	330
			Pull-side	628	126	188	251	314	377	440
25	12	Double acting	Push-side	756	151	227	302	378	454	529
			Pull-side	982	186	295	393	491	589	687

Installation and application



1. Dirty substances in the pipe must be eliminated before cylinder is connected with pipeline to prevent the entrance of impurities into the cylinder.
2. The medium used by cylinder should be filtered to 40 μm or below.
3. Anti-freezing measure shall be adopted under low temperature environment to prevent moisture freezing.
4. If the cylinder is dismantled and stored for a long time, pay attention to conduct anti-rust treatment to the surface. Anti-dust caps shall be added in air inlet and outlet ports.



Compact slide cylinder(Recirculating linear ball bearing) **AIRTAC**

HLQ、HLQL Series



Specification

Bore size(mm)	6	8	12	16	20	25
Number of guide rail	Single guide rail		Double guide rail			
Acting type	Double acting					
Fluid	Air(to be filtered by 40 μm filter element)					
Operating pressure	0.15~0.7MPa(22~100psi)(1.5~7.0bar)					
Proof pressure	1.2MPa(175psi)(12.0bar)					
Temperature °C	-20~70					
Speed range mm/s	50~500					
Stroke tolerance	Stroke ≤ 100 ^{+1.0} ₀			Stroke > 100 ^{+1.5} ₀		
Cushion type	Bumper(Both ends)、Shock absorber					
Sensor switches	CM5H、DMSH(S)					
Port size [Note1]	M5 × 0.8				1/8"	

[Note1] PT thread, G thread, NPT thread are available.
Refer to P353 for detail of sensor switch.

Symbol



Stroke

Bore size (mm)	Standard stroke (mm)										Max.std stroke
6	10	20	30	40	50						50
8	10	20	30	40	50	75					75
12	10	20	30	40	50	75	100				100
16	10	20	30	40	50	75	100	125			125
20	10	20	30	40	50	75	100	125	150		150
25	10	20	30	40	50	75	100	125	150		150

[Note] Consult us for non-standard stroke.

Ordering code

HLQ 20 × 30 S AS □

① ② ③ ④ ⑤ ⑥

① Model	② Bore Size	③ Stroke	④ Magnet	⑤ Adjuster option [Note1]		⑥ Thread type [Note2]		
HLQ: Compact slide cylinder (Double acting type) (Recirculating linear ball bearing) HLQL: Symmetrical Compact slide cylinder (Double acting type) (Recirculating linear ball bearing)	6 8 12 16 20 25	Refer to stroke table for details	S: With magnet	Blank: Without adjuster(Basic type)		Blank: PT G: G T: NPT		
				A: Adjustable rubber stopper(Both ends) 			B: Shock absorber(Both ends) 	
				AS: Adjustable rubber stopper(Extension) 			BS: Shock absorber(Extension) 	
				AF: Adjustable rubber stopper(Retraction) 		BF: Shock absorber(Retraction) 		

[Note1] B type, BS type, BF type are unavailable for bore size of Φ6. [Note2] When the thread is standard, the code is blank.

Compact slide cylinder(Recirculating linear ball bearing) **AIRTAC**

HLQ、HLQL Series

Inner structure and material of major parts

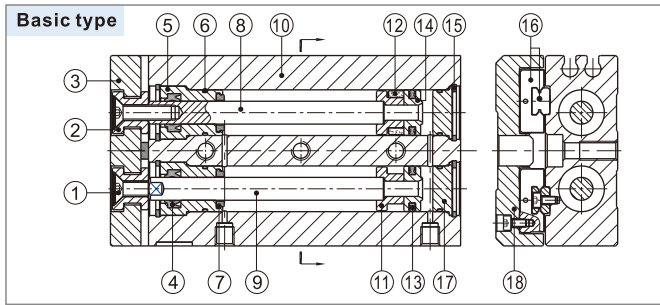

NO.	Item	Material	NO.	Item	Material
1	Screw	Carbon steel	11	Magnet holder	Brass
2	Floating joint	Carbon steel	12	Magnet	Sintered metal (Neodymium-iron-boron)
3	Fixing plate	Aluminum alloy	13	Piston seal	NBR
4	Rod seal	NBR	14	Piston	Brass
5	Front cover	Aluminum alloy	15	C clip	Spring steel
6	O-ring	NBR	16	Linear guide combination	
7	Bumper	TPU	17	Back cover	Brass
8	Piston rod A	Stainless steel	18	Slide table	Aluminum alloy
9	Piston rod B	Carbon steel			
10	Body	Aluminum alloy			

Model Selection Method

Please select compact cylinder's type according to following procedure, and cross reference with data sheets.

A) Operating conditions(According to mounting position and work form)

1. Model used(Bore size, Stroke)
2. Type of cushion(Bumper, Shock absorber)
3. Mounting position of work(Top, front)
4. Mounting direction(Axial, Vertical)
5. Average speed V_a (mm/s)
6. Applied load W (N)
7. Overhang L_1, L_2, L_3 (mm)

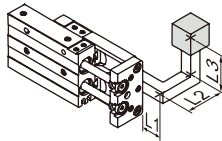
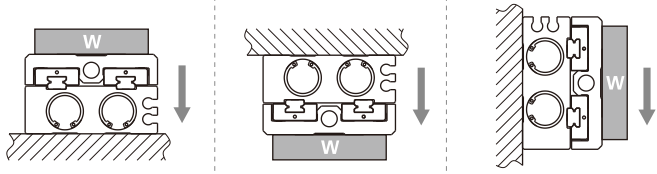

Fig. 1

Explain: L_1 is the distance of load's center beyond the end plank's plane.
If load's center is not beyond the end plank's plane, L_1 is negative.

Fig. 1: Applied load



B) Kinetic energy check

1. Calculate kinetic energy of load E (J)

$$E = \frac{1}{2} \times \frac{W}{g} \times \left(\frac{1.4 \times V_a}{1000} \right)^2$$
2. Calculate allowable kinetic energy E_a (J)

$$E_a = K \times E_{max}$$

K : Mounting work coefficient (Fig 2)
 E_{max} : Maximum allowable kinetic energy (Table 1)
3. Check that kinetic energy of load doesn't exceed allowable kinetic energy: $E \leq E_a$

C) Load check

1. Calculate allowable applied load W_a (N)

$$W_a = K \times \beta \times W_{max}$$

K : Mounting work coefficient (Fig 2)
 W_{max} : Maximum allowable applied load (Table 1)
 β : Applied load coefficient (Fig 3)
2. Check that load(W) doesn't exceed allowable applied load(W_a): $W \leq W_a$

Fig 2: Mounting work coefficient (K)

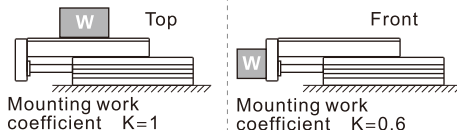
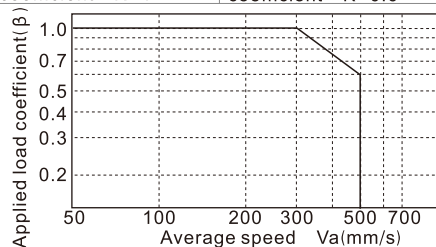

Fig 3: Applied load coefficient (β)



D) Moment check

Horizontal

1. Calculate actual moment: $M_p, M_{p0}, M_y, M_{y0}, M_r, M_{r0}$ (Nm)

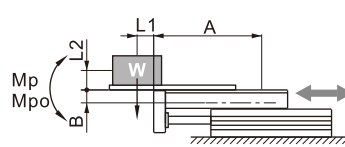

Dynamic moment:
 $M_p = W \times (L_1 + A) / 1000$

Static moment:
 $M_{p0} = \frac{W \times (L_1 + A)}{1000} + \frac{W \times a \times (L_2 + B)}{1000 \times g}$

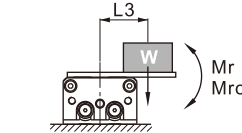

Dynamic moment:
 $M_r = W \times L_3 / 1000$

Static moment:
 $M_{r0} = (W \times a \times L_3) / 1000g$

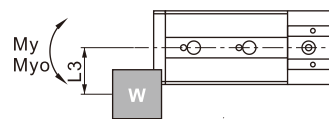

Dynamic moment:
 $M_y = 0$

Static moment:
 $M_{y0} = (W \times a \times L_3) / 1000g$

2. Check

Dynamic moment:	$\frac{M_p}{M_{p_{max}}} + \frac{M_y}{M_{y_{max}}} + \frac{M_r}{M_{r_{max}}} \leq 1$
Static moment:	$\frac{M_{p0}}{M_{p0_{max}}} + \frac{M_{y0}}{M_{y0_{max}}} + \frac{M_{r0}}{M_{r0_{max}}} \leq 1$

Vertical

1. Calculate actual moment: M_p, M_{p0}, M_y, M_{y0} (Nm)

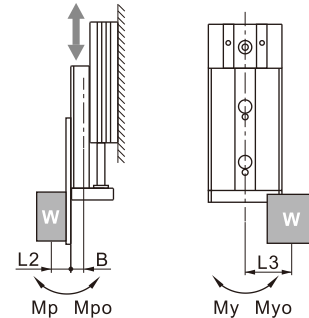

Dynamic moment:
 $M_p = W \times (L_2 + B) / 1000$

Static moment:
 $M_{p0} = \frac{W \times (L_2 + B)}{1000} + \frac{W \times a \times (L_2 + B)}{1000 \times g}$

Dynamic moment:
 $M_y = W \times L_3 / 1000$

Static moment:
 $M_{y0} = \frac{W \times a \times L_3}{1000g} + \frac{W \times L_3}{1000}$

2. Check

Dynamic moment:	$\frac{M_p}{M_{p_{max}}} + \frac{M_y}{M_{y_{max}}} \leq 1$
Static moment:	$\frac{M_{p0}}{M_{p0_{max}}} + \frac{M_{y0}}{M_{y0_{max}}} \leq 1$

Explain:

$L_1/L_2/L_3$: The distance of load center to mount plane (Determined by actuality).
 A/B : Correction value for center position distance of moment (Refer to table 2).

$M_{p_{max}}/M_{y_{max}}/M_{r_{max}}/M_{p0_{max}}/M_{y0_{max}}/M_{r0_{max}}$: Maximum allowable moment (Refer to table 2).
 g : Acceleration of gravity ($g = 9.81 \text{ m/s}^2$).

a : Acceleration of inertia

(Bumper: $a = 1600 \times (V_a/1000)^2$, Shock absorber: $a = 400 \times (V_a/1000)^2$)

W : Load weight (Determined by actuality).

Compact slide cylinder(Recirculating linear ball bearing) **AIRTAC**

HLQ、HLQL Series

Table 1: Maximum allowable kinetic energy(E_{max})
Maximum allowable applied load(W_{max})

Model	Max. allowable kinetic energy		E _{max} (J)	Max. allowable applied load W _{max} (N)
	Basic type	Rubber stopper type		
HLQ6	0.01	0.01	—	4
HLQ8	0.024	0.024	0.048	8
HLQ12	0.05	0.05	0.1	15
HLQ16	0.1	0.1	0.2	30
HLQ20	0.13	0.13	0.26	40
HLQ25	0.22	0.22	0.44	70

Note: Symbol and unit

Symbol	Item	Unit
A, B	Correction value for center position distance of moment	mm
a	Acceleration of inertia	—
E	Kinetic energy	J
E _a	Allowable kinetic energy	J
E _{max}	Maximum allowable kinetic energy	J
g	Acceleration of gravity g=9.81	m/s ²
K	Mounting work coefficient	—
L1, L2, L3	Overhang	mm
M _p , M _y , M _r	Dynamic moment(Pitch、Yaw、Roll)	Nm
M _{pmax} , M _{ymax} , M _{rmax}	Maximum allowable dynamic moment (Pitch、Yaw、Roll)	Nm
M _{po} , M _{yo} , M _{ro}	Static moment(Pitch、Yaw、Roll)	Nm
M _{po_max} , M _{yo_max} , M _{ro_max}	Maximum allowable static moment (Pitch、Yaw、Roll)	Nm
V _a	Average speed	mm/s
W	Applied load	N
W _{max}	Maximum allowable applied load	N
β	Applied load coefficient	—

Table 2: Maximum allowable moment(Nm),
Correction value for center position distance of moment(mm)

Bore size	Stroke	Static moment			Dynamic moment			Correction value	
		M _{po_max}	M _{yo_max}	M _{ro_max}	M _{p_max}	M _{y_max}	M _{r_max}	A	B
6	10	3.3	3.8	2.6	0.7	0.7	0.6	30	7
	20	3.3	3.8	2.6	0.7	0.8	0.6	40	
	30	3.3	3.8	2.6	0.7	0.8	0.6	50	
	40	7.2	7.9	3.6	1.3	1.3	0.6	60	
	50	12.4	12.7	4.7	1.8	1.8	0.6	70	
8	10	10.1	9.1	8.8	2.5	2.5	2.0	30	7
	20	10.1	9.1	8.8	2.6	2.6	2.0	40	
	30	10.1	9.1	8.8	2.8	2.8	2.0	50	
	40	12.4	10.8	10.1	3.4	3.4	2.3	60	
	50	23.6	24.8	13.9	4.4	4.4	2.1	70	
12	75	32.8	35.3	16.4	4.6	4.6	1.8	95	11
	10	8.5	8.5	13.6	2.5	2.5	4	32	
	20	8.5	8.5	13.6	2.5	2.5	4	44	
	30	8.5	8.5	13.6	2.5	2.5	4	54	
	40	8.5	8.5	13.6	2.5	2.5	4	62	
16	50	8.5	8.5	13.6	2.5	2.5	4	72	12
	75	52.3	52.3	85.6	18.9	18.9	13	115	
	100	53.9	53.9	86.9	19.5	19.5	13	142	
	10	33.6	33.6	35.2	8.4	8.4	8.8	49	
	20	33.6	33.6	35.2	8.4	8.4	8.8	49	
20	30	33.6	33.6	35.2	8.4	8.4	8.8	59	14
	40	33.6	33.6	35.2	8.4	8.4	8.8	69	
	50	33.6	33.6	35.2	8.4	8.4	8.8	79	
	75	70.2	70.2	62.5	28.1	28.1	25	120	
	100	76.6	76.6	62.5	38.3	38.3	25	150	
25	125	78	78	62.5	39	39	25	175	17
	10	34.8	34.8	36.8	8.7	8.7	9.2	53	
	20	34.8	34.8	36.8	8.7	8.7	9.2	53	
	30	34.8	34.8	36.8	8.7	8.7	9.2	63	
	40	34.8	34.8	36.8	8.7	8.7	9.2	73	
25	50	34.8	34.8	36.8	8.7	8.7	9.2	83	14
	75	70.2	70.2	74.5	28.1	28.1	29.7	123	
	100	76.6	76.6	74.5	38.3	38.3	29.7	157	
	125	78	78	74.5	39	39	29.7	178	
	150	98.4	98.4	74.5	49.2	49.2	29.7	210	
25	10	56.7	56.7	51	16.2	16.2	17	60	17
	20	56.7	56.7	51	16.2	16.2	17	60	
	30	56.7	56.7	51	16.2	16.2	17	70	
	40	56.7	56.7	51	16.2	16.2	17	80	
	50	56.7	56.7	51	16.2	16.2	17	90	
25	75	122.5	122.5	138.5	49	49	55.4	130	17
	100	173.8	173.8	138.5	79	79	55.4	168	
	125	217	217	138.5	108.6	108.6	55.4	205	
	150	221.8	221.8	138.5	110.9	110.9	55.4	230	

Installation and application

1. How to mount cylinder:

1.1) Cylinder can be mounted from 3 directions

Vertical Mounting(Body thread holes)

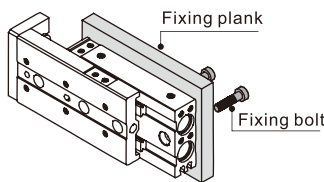

Vertical Mounting(Body through holes)

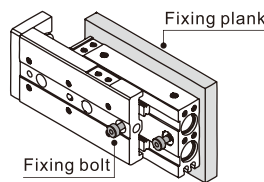

Axial Mounting (Body thread holes)

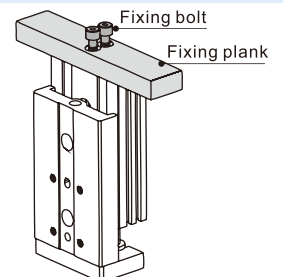

1.2) When mounting an compact slide cylinder, screws of appropriate length should be used and tightened properly within the maximum tightening torque.

If screws are tightened beyond designed limits, malfunction may occur. If they are tightened insufficiently, it may result in sliding or falling off from its position.

Vertical Mounting(Body thread holes)

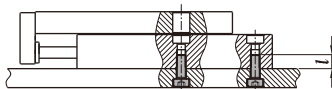

Model	Bolt used	Max. tightening torque (Nm)	Max. screw-in depth(mm)
HLQ6	M4 × 0.7	2.1	8
HLQ8	M4 × 0.7	2.1	8
HLQ12	M5 × 0.8	4.4	10
HLQ16	M6 × 1.0	4.4	10
HLQ20	M6 × 1.0	7.4	12
HLQ25	M8 × 1.25	18.0	16

Vertical Mounting(Body through holes)

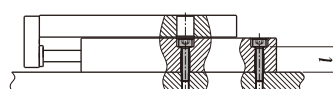

Model	Bolt used	Max. tightening torque (Nm)	Max. screw-in depth(mm)
HLQ6	M3 × 0.5	1.2	8.0
HLQ8	M3 × 0.5	1.2	9.6
HLQ12	M4 × 0.7	2.8	13.4
HLQ16	M5 × 0.8	5.7	16.7
HLQ20	M5 × 0.8	5.7	22.0
HLQ25	M6 × 1.0	10.0	27.0

Axial Mounting(Body thread holes)

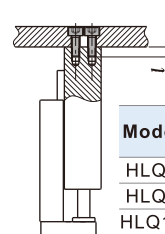

Model	Bolt used	Max. tightening torque (Nm)	Max. screw-in depth(mm)
HLQ6	M2.5×0.45	0.5	3.5
HLQ8	M3 × 0.5	0.9	4.0
HLQ12	M4 × 0.7	2.1	6.0
HLQ16	M5 × 0.8	4.4	7.0
HLQ20	M5 × 0.8	4.4	8.0
HLQ25	M6 × 1.0	7.4	10.0



Compact slide cylinder(Recirculating linear ball bearing) **AIRTAC**

HLQ、HLQL Series

2. Work Piece Mounting:

2.1) Work pieces can be mounted on 2 surfaces of the compact slide.

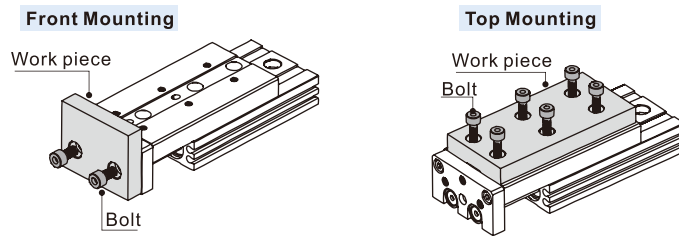

2.2) When mounting a work piece, tighten the bolts properly at a torque value within the limiting range. Use bolts at least 0.5mm shorter than maximum thread depth to prevent bolts from contacting the guide block. If the bolts are too long, they hit the guide block and cause damage.

Front Mounting				Top Mounting			
Model	Bolt used	Max. tightening torque (Nm)	Max. screw-in depth(mm)	Model	Bolt used	Max. tightening torque (Nm)	Max. screw-in depth(mm)
HLQ6	M3×0.4	0.9	5	HLQ6	M3×0.5	0.9	4.7
HLQ8	M4×0.7	2.1	6	HLQ8	M3×0.5	0.9	4.7
HLQ12	M5×0.8	4.4	8	HLQ12	M4×0.7	2.1	5.0
HLQ16	M6×1.0	7.4	10	HLQ16	M5×0.8	4.4	5.0
HLQ20	M6×1.0	7.4	13	HLQ20	M5×0.8	4.4	8.0
HLQ25	M8×1.25	18.0	15	HLQ25	M6×1.0	7.4	9.0

2.3) Since the table is supported by the linear guide, take care not to apply strong impact or large moment to the guide section.

2.4) Hold the slide when fastening work pieces to it with bolts, If the body is held while tightening bolts, excessive moment may damage guide section.

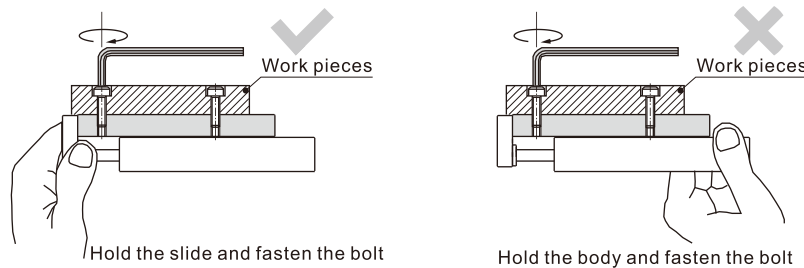

3. About shock absorber:

3.1) Shock absorbers are expendable. Promptly replace them when energy absorbing capacity decreases.

3.2) Never turn or adjust the screws on bottom of the shock absorber body. The screws are not for adjusting. Otherwise would cause oil leakage.

3.3) Follow the table for tightening torque of shock absorber to lock nuts.

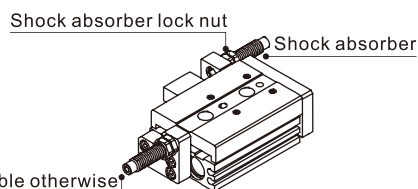

The screws are not adjustable otherwise would cause oil leakage.

Model	Shock absorber	Tightening torque
HLQ6	Without shock absorber	
HLQ8	ACA0806-1N	1.67(Nm)
HLQ12	ACA0806-1N	1.67(Nm)
HLQ16	ACA1007-1N	3.14(Nm)
HLQ20	ACA1210-1N	3.14(Nm)
HLQ25	ACA1412-1N	10.8(Nm)

4. How to mount sensor switch:

4.1) HLQ Series are all with magnet. The matching sensor switches are CMSH, DMSH(S) series.

4.2) Maintain a minimum spacing of at least 3mm if two compact cylinders are used side by side in order to avoid malfunction.

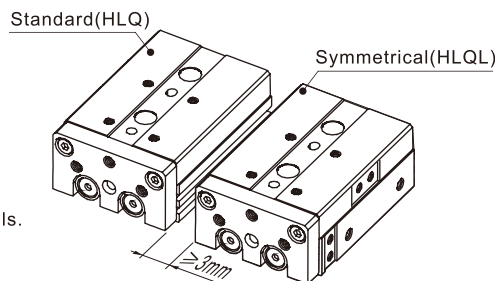

5. Make sure to connect the compact cylinder to speed controller at the meter-out side, and the speed of compact cylinder must below 500mm/s.

6. Don't apply a load beyond the range of the operation limits. Different load or torque will cause different deflection to table, please see below for details.

Compact slide cylinder(Recirculating linear ball bearing) **AIRTAC**

HLQ、HLQL Series

6.1) Table deflection due to pitch moment:

Table deflection (arrow) when a load acts upon the section marked with the arrow at the full stroke of the compact slide.

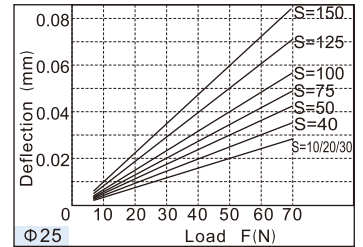
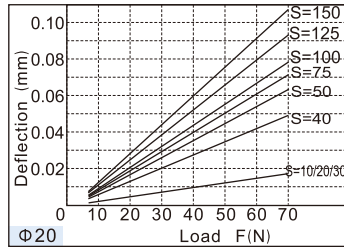
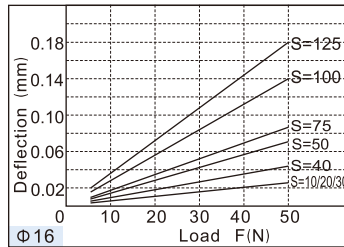
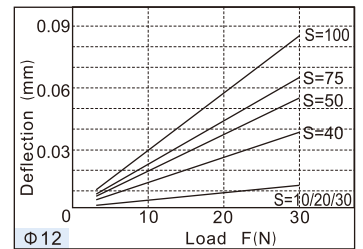
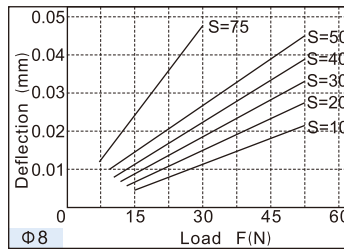
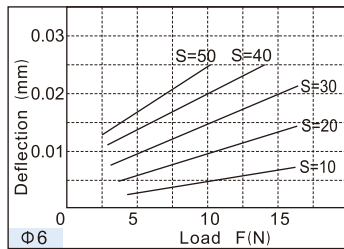

6.2) Table deflection due to yaw moment:

Table deflection (arrow) when a load acts upon the section marked with the arrow at the full stroke of the compact slide.

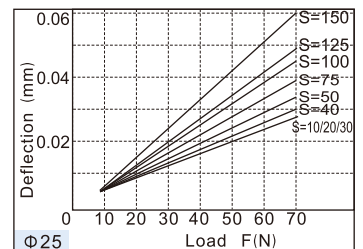
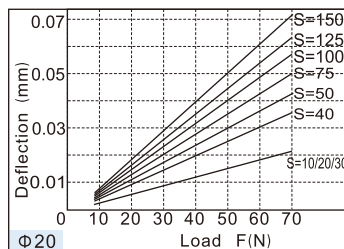
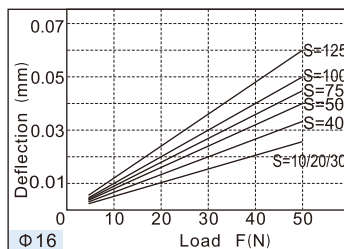
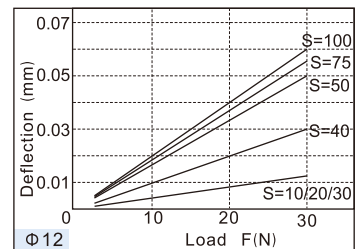
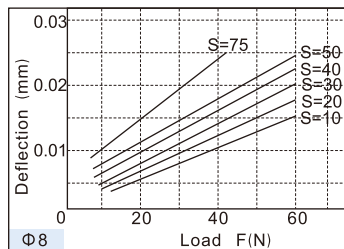
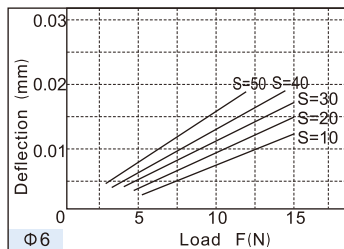
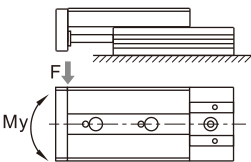

6.3) Table deflection due to roll moment:

Table deflects (A) when a load acts upon section F at the full stroke of the compact slide.

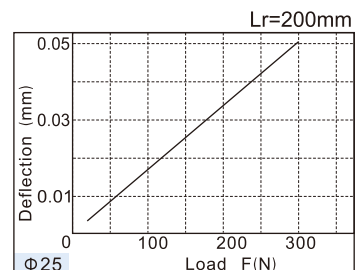
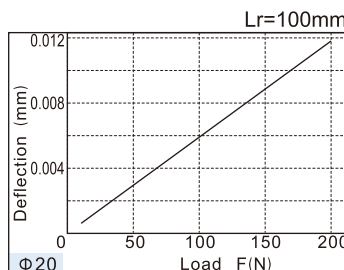
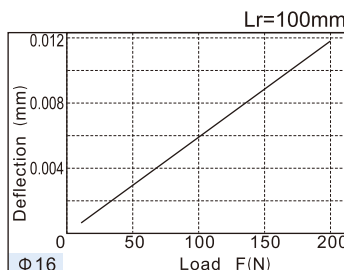
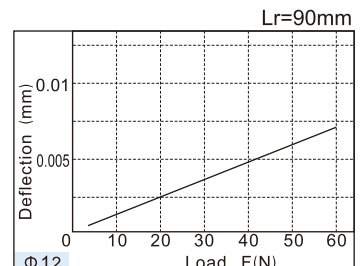
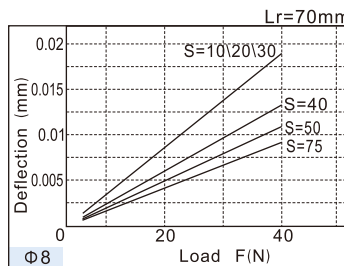
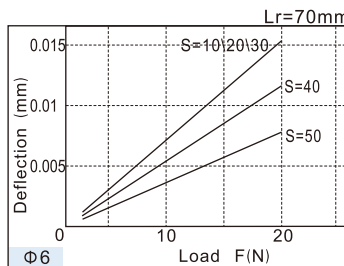
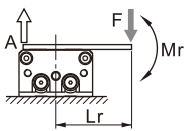

Compact slide cylinder(Recirculating linear ball bearing) **AIRTAC**

HLQ、HLQL Series

Dimensions

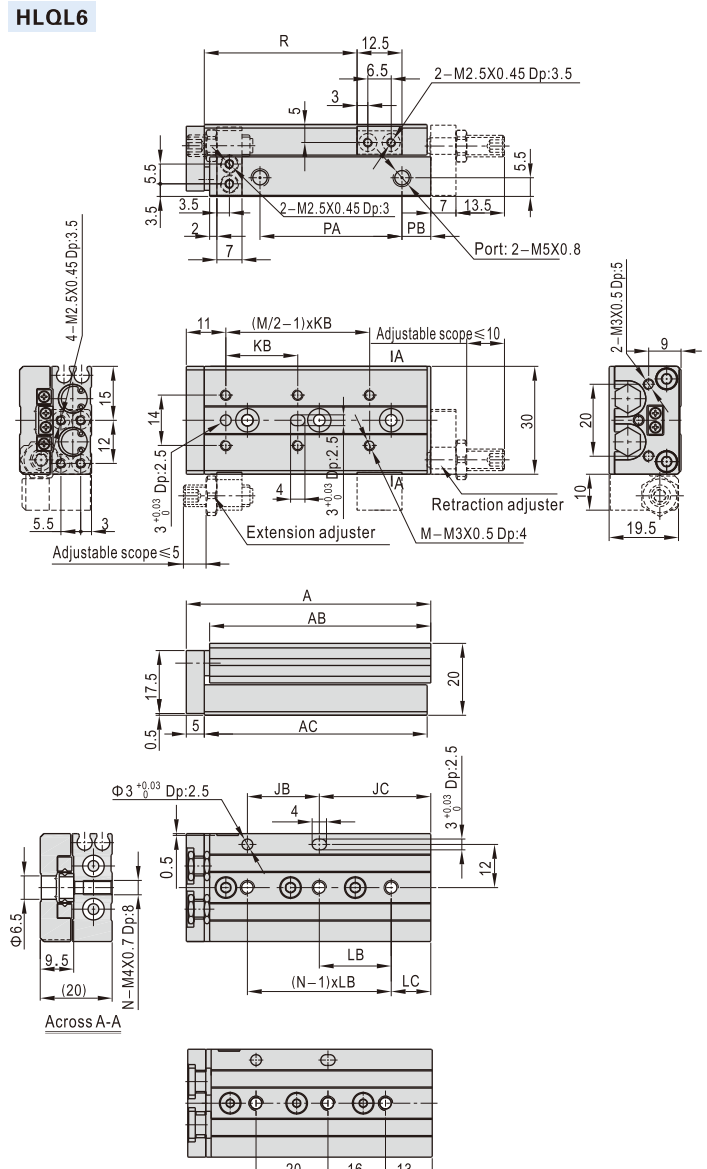
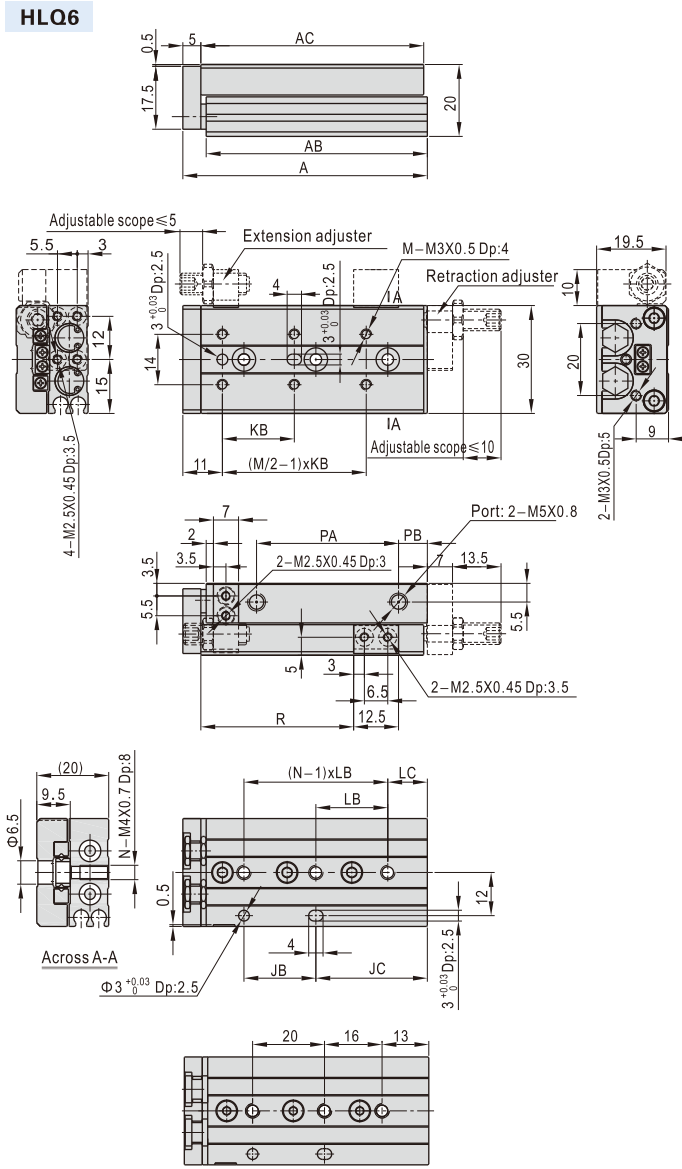

HLQ6 × 30

Stroke\Item	A	AB	AC	JB	JC	KB	LB	LC	M	N	PA	PB	R
10	48	41.5	42	16	13	22	23	6	4	2	16	9	21.5
20	58	51.5	52	26	13	25	26	13	4	2	26	9	31.5
30	68	61.5	62	20	29	21	-	-	6	3	36	9	41.5
40	86	79.5	80	28	39	26	28	11	6	3	47	16	51.5
50	96	89.5	90	28	49	27	28	21	6	3	64	9	61.5

HLQL6 × 30

Stroke\Item	A	AB	AC	JB	JC	KB	LB	LC	M	N	PA	PB	R
10	48	41.5	42	16	13	22	23	6	4	2	16	9	21.5
20	58	51.5	52	26	13	25	26	13	4	2	26	9	31.5
30	68	61.5	62	20	29	21	-	-	6	3	36	9	41.5
40	86	79.5	80	28	39	26	28	11	6	3	47	16	51.5
50	96	89.5	90	28	49	27	28	21	6	3	64	9	61.5



Compact slide cylinder(Recirculating linear ball bearing) **AIRTAC**

HLQ、HLQL Series

HLQ8

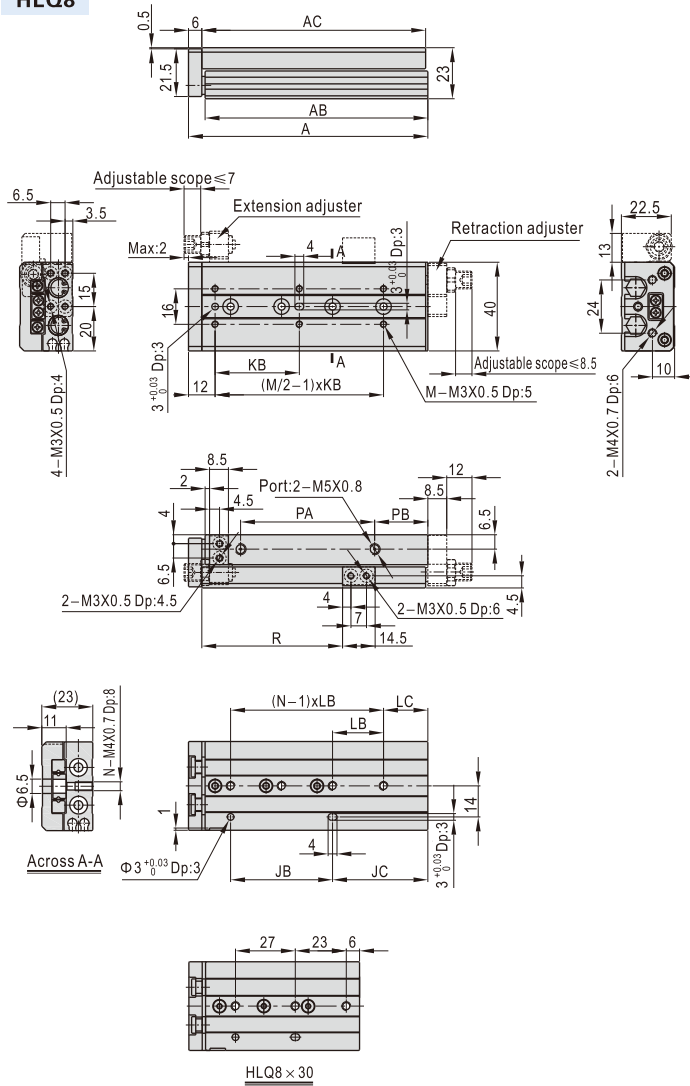

Stroke\Item	A	AB	AC	JB	JC	KB	LB	LC	M	N	PA	PB	R
10	53	45.5	46	19	13	25	25	7	4	2	17.5	10.5	23.5
20	63	55.5	56	28	14	25	28	14	4	2	28	10	33.5
30	77	69.5	70	27	29	26	-	-	6	3	42	10	43.5
40	91	83.5	84	31	39	32	31	8	6	3	54	12	53.5
50	116	108.5	109	58	37	46	29	8	6	4	79	12	63.5
75	144	136.5	137	60	63	50	30	33	6	4	109	10	88.5

HLQ8(With shock absorber)

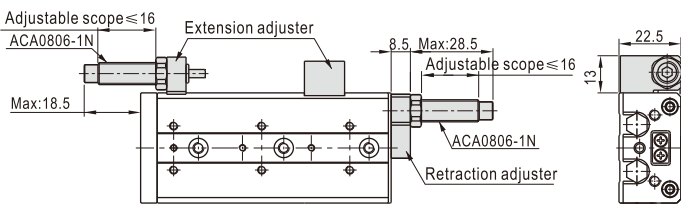

HLQL8

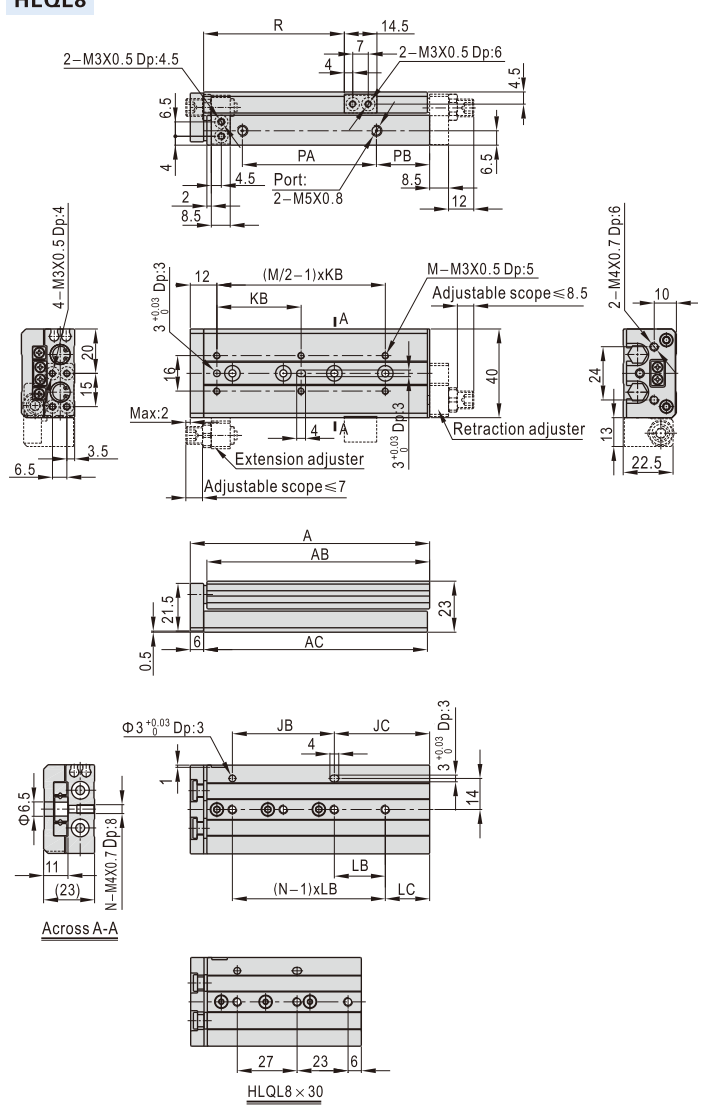

Stroke\Item	A	AB	AC	JB	JC	KB	LB	LC	M	N	PA	PB	R
10	53	45.5	46	19	13	25	25	7	4	2	17.5	10.5	23.5
20	63	55.5	56	28	14	25	28	14	4	2	28	10	33.5
30	77	69.5	70	27	29	26	-	-	6	3	42	10	43.5
40	91	83.5	84	31	39	32	31	8	6	3	54	12	53.5
50	116	108.5	109	58	37	46	29	8	6	4	79	12	63.5
75	144	136.5	137	60	63	50	30	33	6	4	109	10	88.5

HLQL8(With shock absorber)

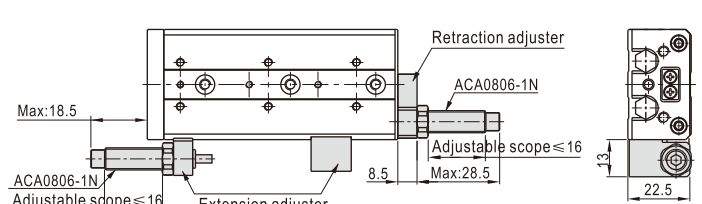

Compact slide cylinder(Recirculating linear ball bearing) **AIRTAC**

HLQ、HLQL Series

HLQ12

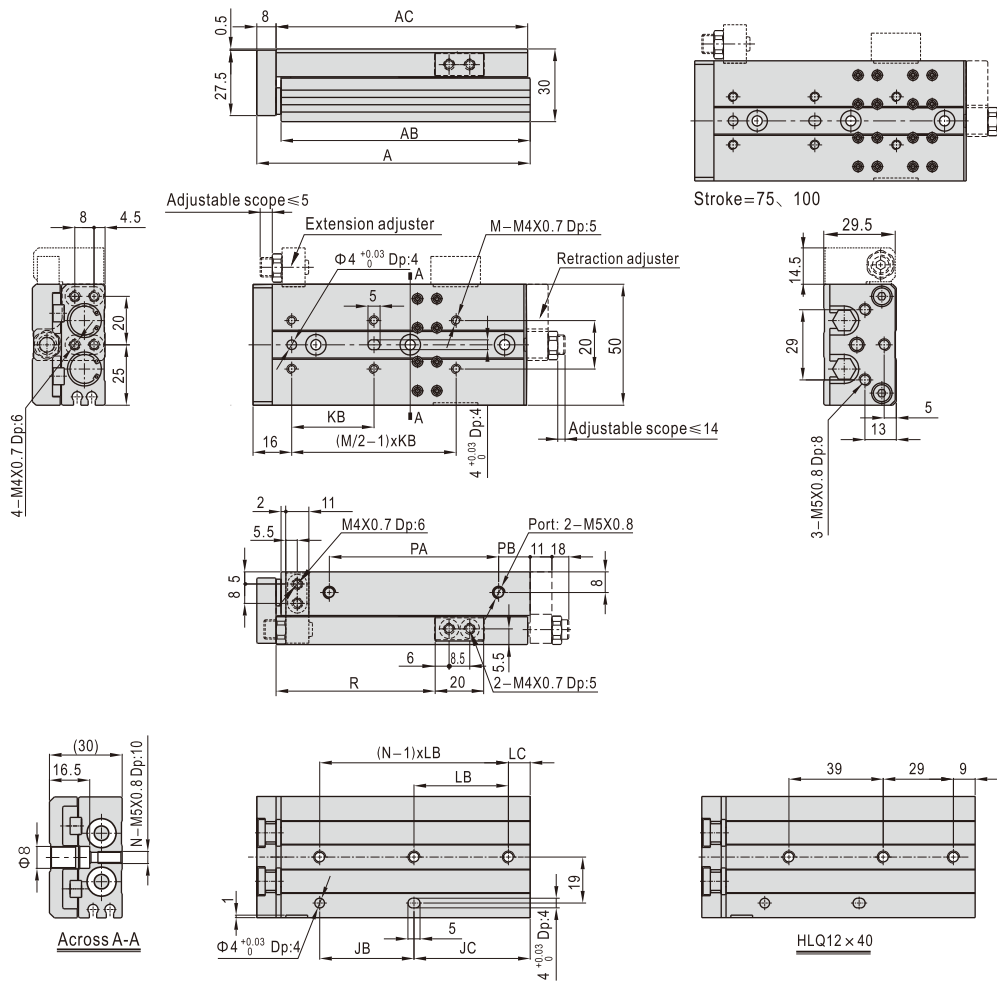

Stroke\Item	A	AB	AC	JB	JC	KB	LB	LC	M	N	PA	PB	R
10	76	66	67	32	18	28	32	18	4	2	32.5	13	35
20	76	66	67	32	18	28	32	18	4	2	32.5	13	45
30	86	76	77	40	20	38	40	20	4	2	42.5	13	55
40	103	93	94	39	38	34	-	-	6	3	59.5	13	65
50	113	103	104	39	48	34	39	9	6	3	69.5	13	75
75	157	147	148	72	59	36	36	23	8	4	113.5	13	99
100	182	172	173	72	84	36	36	12	10	5	134.5	17	124

HLQ12(With shock absorber)

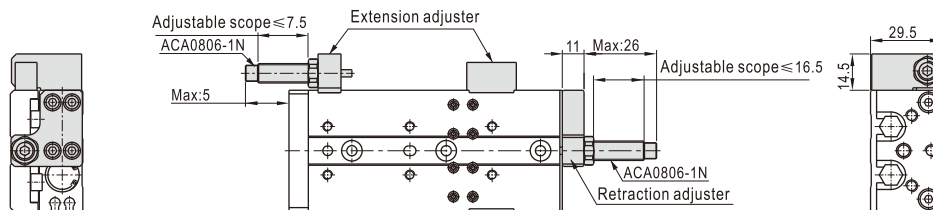

Compact slide cylinder(Recirculating linear ball bearing) **AIRTAC**

HLQ、HLQL Series

HLQL12

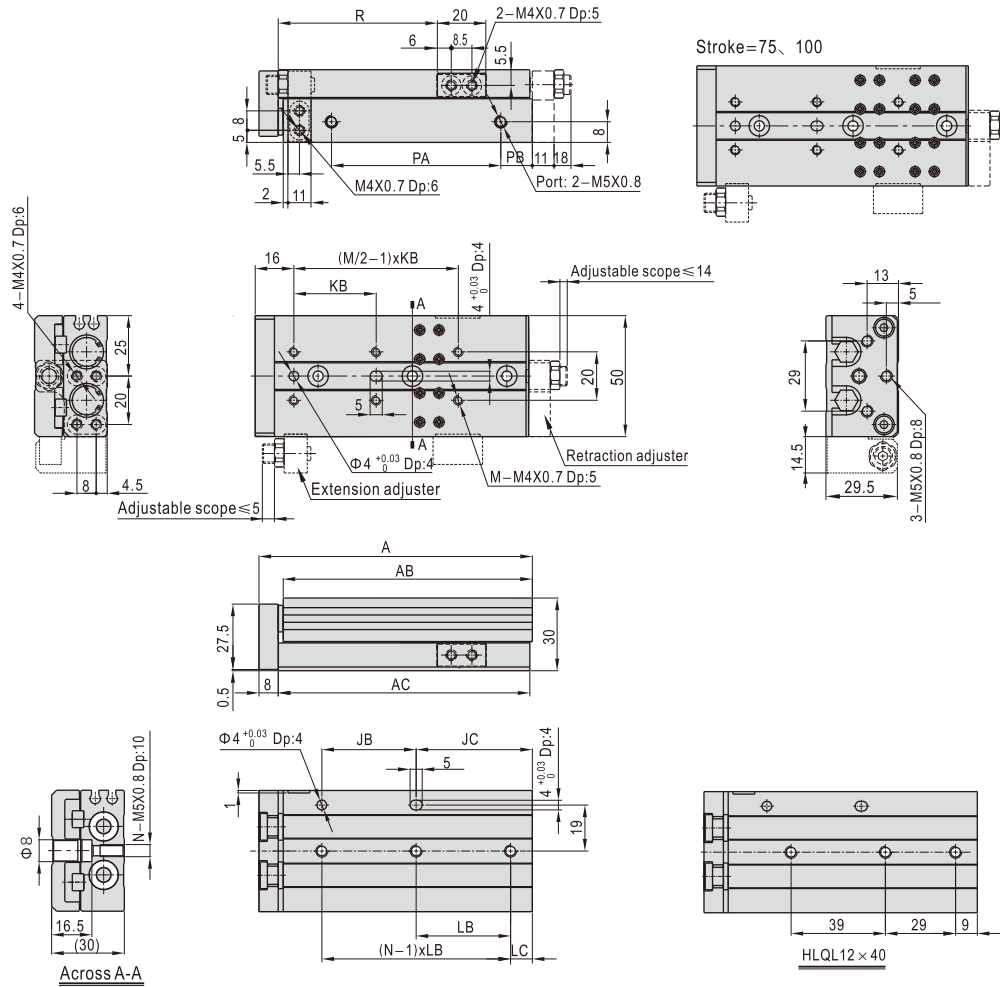

Stroke\Item	A	AB	AC	JB	JC	KB	LB	LC	M	N	PA	PB	R
10	76	66	67	32	18	28	32	18	4	2	32.5	13	35
20	76	66	67	32	18	28	32	18	4	2	32.5	13	45
30	86	76	77	40	20	38	40	20	4	2	42.5	13	55
40	103	93	94	39	38	34	-	-	6	3	59.5	13	65
50	113	103	104	39	48	34	39	9	6	3	69.5	13	75
75	157	147	148	72	59	36	36	23	8	4	113.5	13	99
100	182	172	173	72	84	36	36	12	10	5	134.5	17	124

HLQL12(With shock absorber)

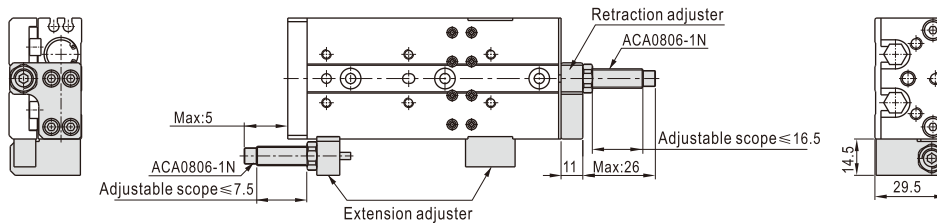

Compact slide cylinder(Recirculating linear ball bearing) **AIRTAC**

HLQ、HLQL Series

HLQL16

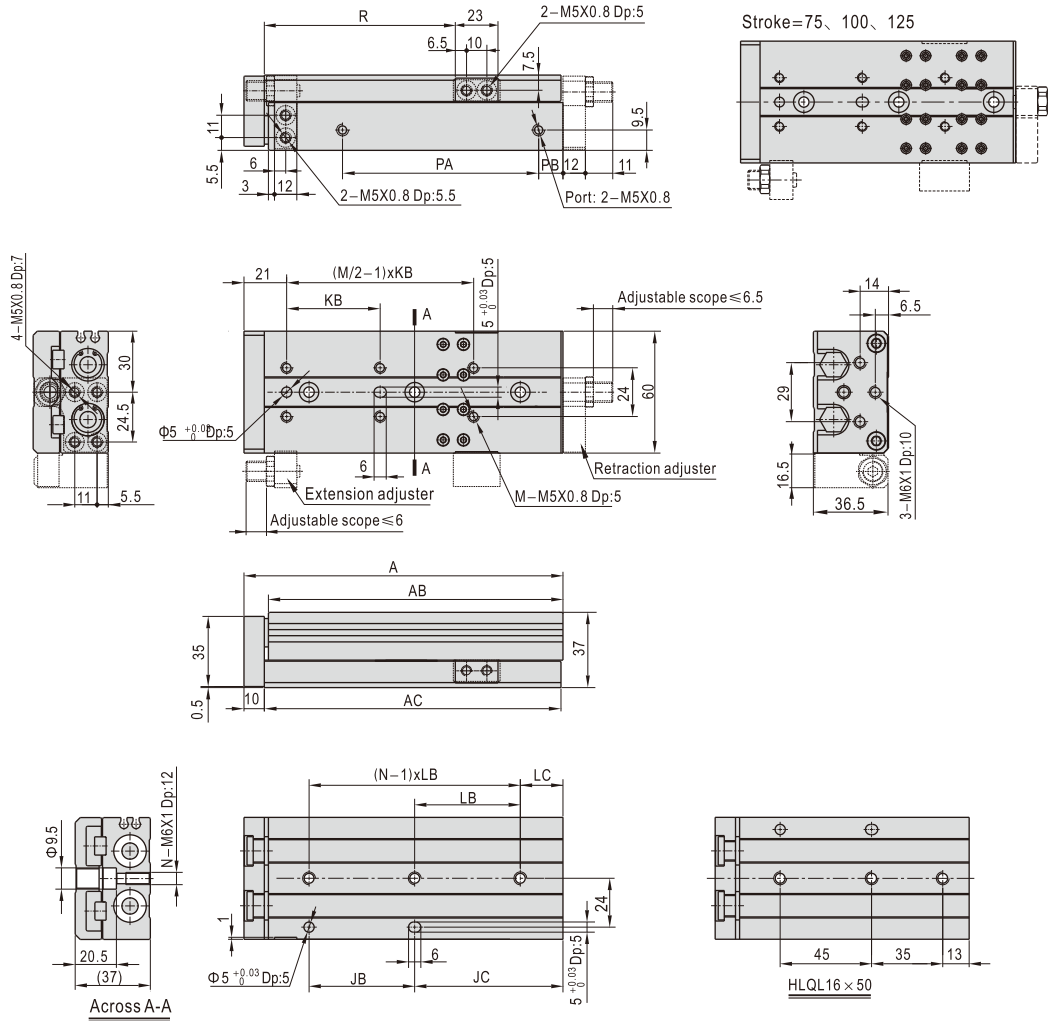

Stroke\Item	A	AB	AC	JB	JC	KB	LB	LC	M	N	PA	PB	R
10	89	77	78	39	18	38	39	18	4	2	40.5	12	28.5
20	89	77	78	39	18	38	39	18	4	2	40.5	12	38.5
30	99	87	88	48	19	48	48	19	4	2	50.5	12	48.5
40	109	97	98	58	19	58	58	19	4	2	60.5	12	58.5
50	125	113	114	45	48	40	-	-	6	3	70.5	18	68.5
75	157	145	146	52	73	46	52	21	6	3	108.5	12	93.5
100	200	188	189	88	80	44	44	36	8	4	151.5	12	118.5
125	225	213	214	88	105	44	44	17	10	5	176.5	12	143.5

HLQL16(With shock absorber)

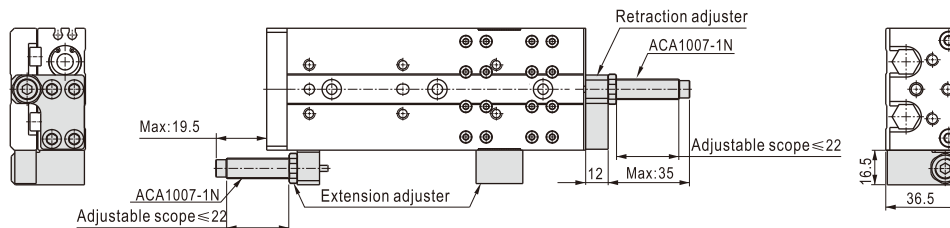

Compact slide cylinder(Recirculating linear ball bearing) **AIRTAC**

HLQ、HLQL Series

HLQ20

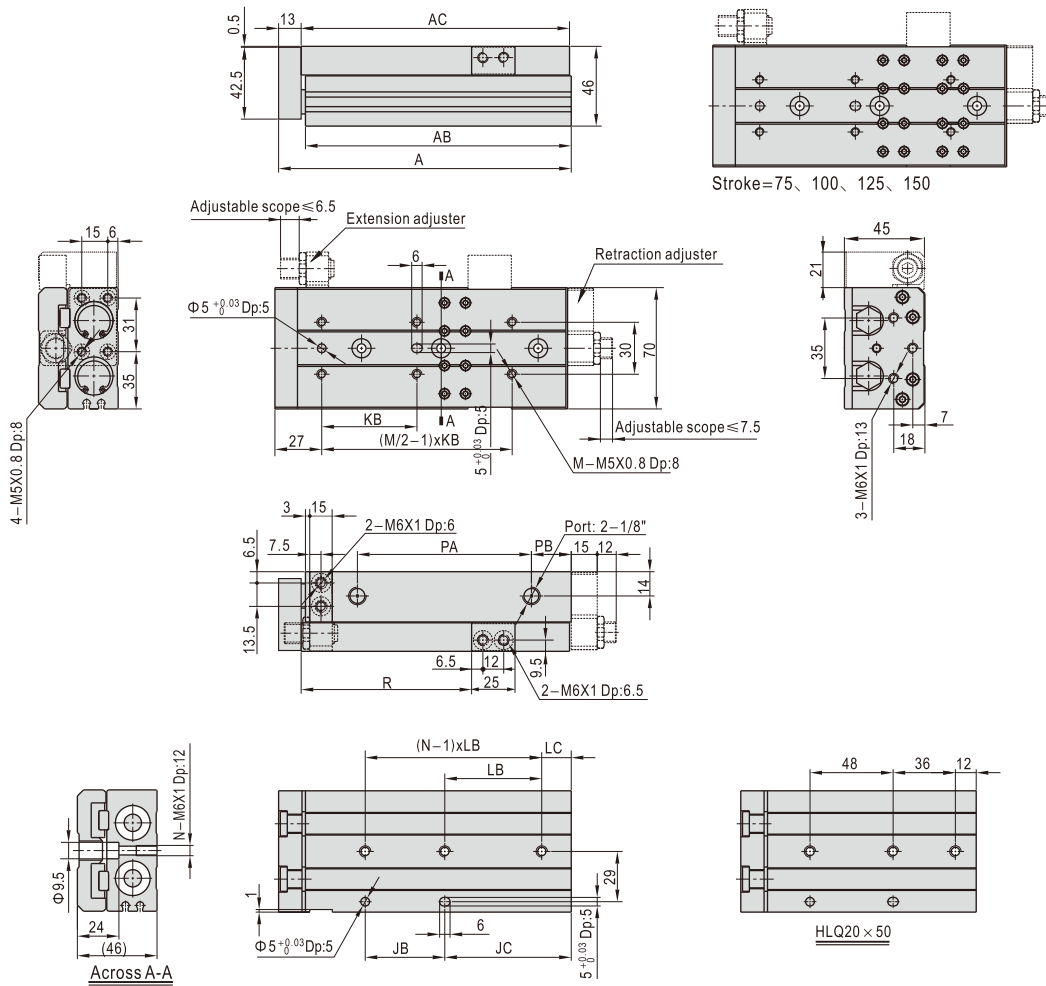

Stroke\Item	A	AB	AC	JB	JC	KB	LB	LC	M	N	PA	PB	R
10	108	92.5	94	50	18	45	46	22	4	2	46.5	16	32.5
20	108	92.5	94	50	18	40	46	22	4	2	46.5	16	42.5
30	108	92.5	94	50	18	48	46	22	4	2	46.5	16	52.5
40	118	102.5	104	56	22	58	56	22	4	2	56.5	16	62.5
50	136	120.5	122	48	48	42	-	-	6	3	72.5	18	72.5
75	169	153.5	155	56	73	55	56	17	6	3	98.5	25	97.5
100	226	210.5	212	112	74	50	56	18	8	4	155.5	25	122.5
125	254	238.5	240	118	96	55	59	37	8	4	183.5	25	147.5
150	282	266.5	268	124	118	62	62	56	8	4	211.5	25	172.5

HLQ20(With shock absorber)

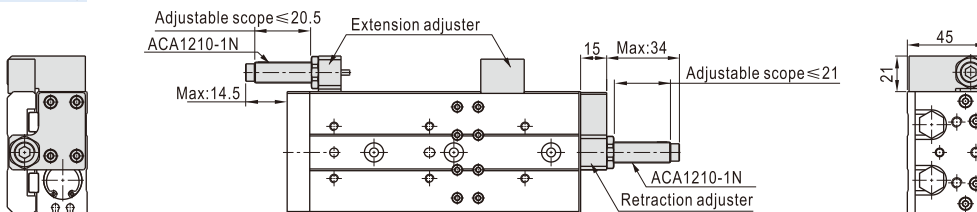

Compact slide cylinder(Recirculating linear ball bearing) **AIRTAC**

HLQ、HLQL Series

HLQL20

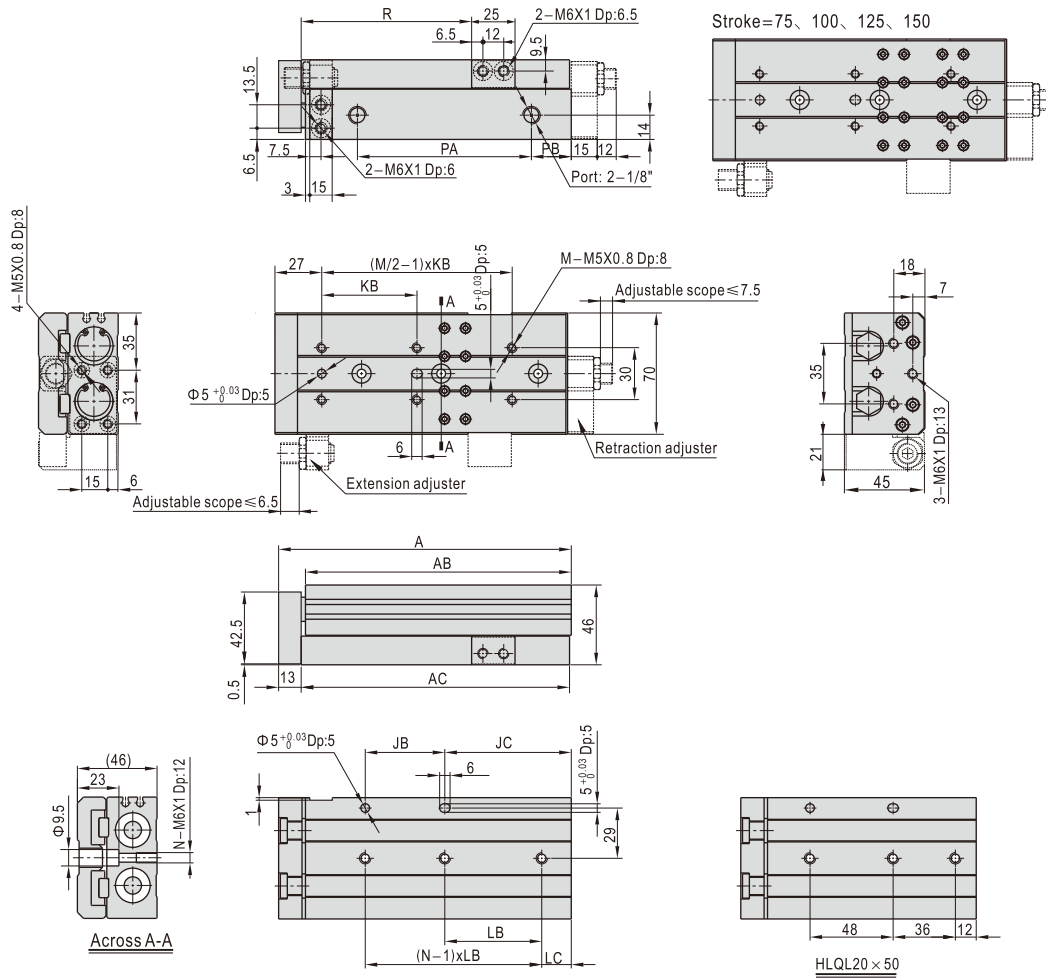

Stroke\Item	A	AB	AC	JB	JC	KB	LB	LC	M	N	PA	PB	R
10	108	92.5	94	50	18	45	46	22	4	2	46.5	16	32.5
20	108	92.5	94	50	18	40	46	22	4	2	46.5	16	42.5
30	108	92.5	94	50	18	48	46	22	4	2	46.5	16	52.5
40	118	102.5	104	56	22	58	56	22	4	2	56.5	16	62.5
50	136	120.5	122	48	48	42	-	6	3	72.5	18	72.5	
75	169	153.5	155	56	73	55	56	17	6	3	98.5	25	97.5
100	226	210.5	212	112	74	50	56	18	8	4	155.5	25	122.5
125	254	238.5	240	118	96	55	59	37	8	4	183.5	25	147.5
150	282	266.5	268	124	118	62	62	56	8	4	211.5	25	172.5

HLQL20(With shock absorber)

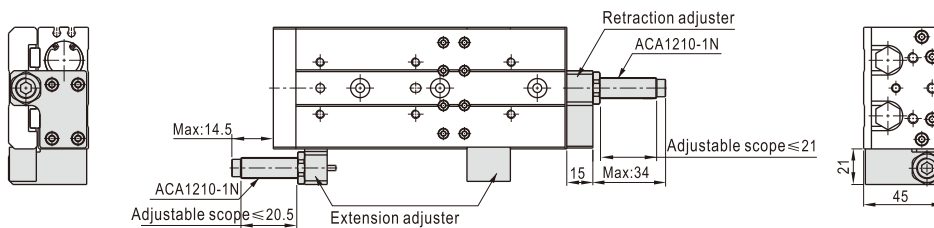

Compact slide cylinder(Recirculating linear ball bearing) **AIRTAC**

HLQ、HLQL Series

HLQ25

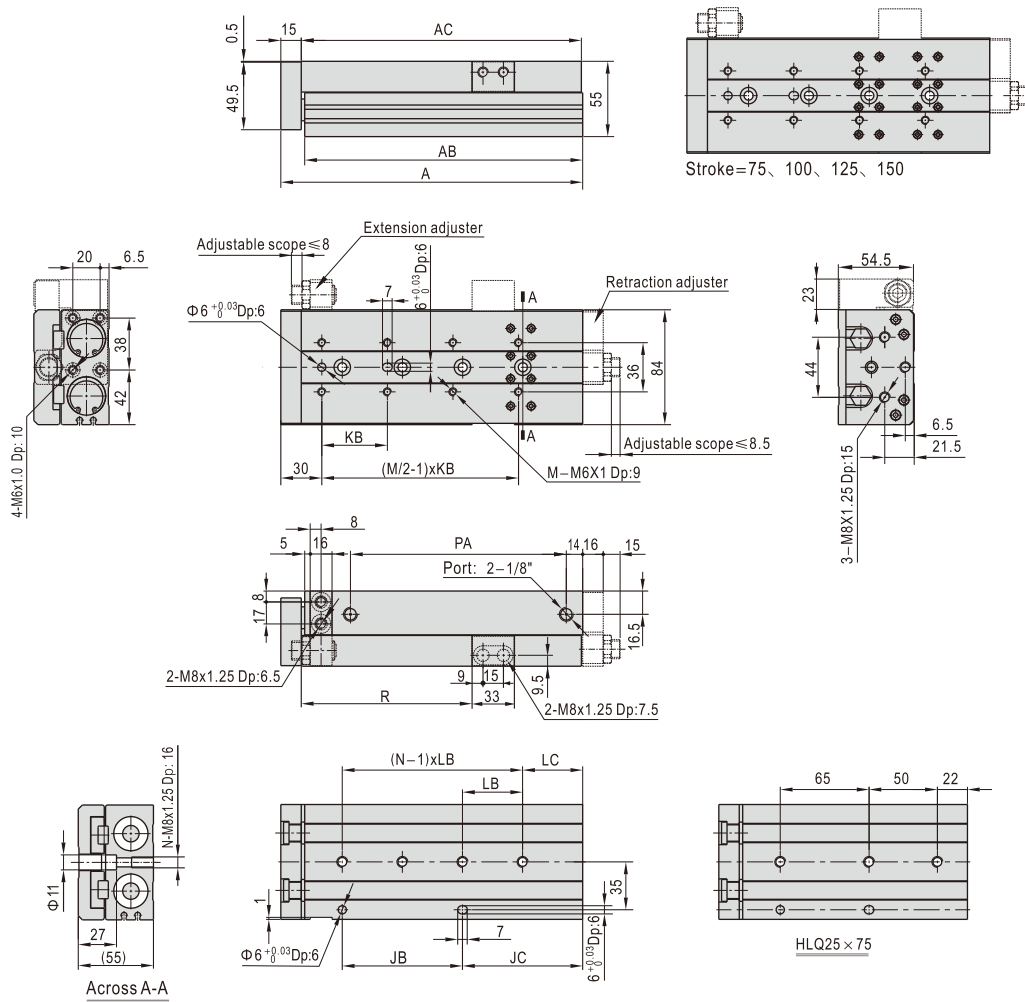

Stroke\Item	A	AB	AC	JB	JC	KB	LB	LC	M	N	PA	R
10	123	105.5	107	55	23	55	55	23	4	2	58	35
20	123	105.5	107	55	23	46	55	23	4	2	58	45
30	123	105.5	107	55	23	55	55	23	4	2	58	55
40	133	115.5	117	65	23	65	65	23	4	2	68	65
50	157	139.5	141	80	32	75	80	32	4	2	92	75
75	182	164.5	166	65	72	60	-	-	6	3	117	100
100	221	203.5	205	88	88	48	44	44	8	4	156	125
125	274	256.5	258	132	97	60	66	31	8	4	209	150
150	299	281.5	283	132	122	65	66	56	8	4	234	175

HLQ25(With shock absorber)

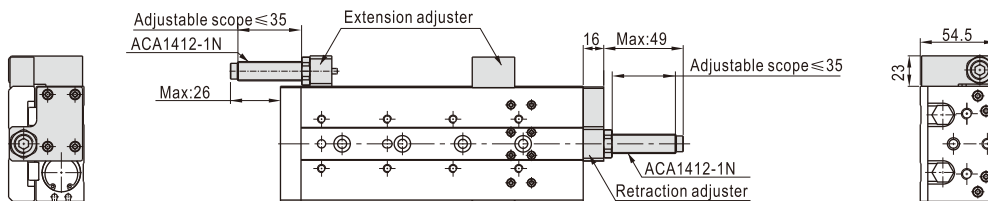

Compact slide cylinder(Recirculating linear ball bearing) **AIRTAC**

HLQ、HLQL Series

HLQL25

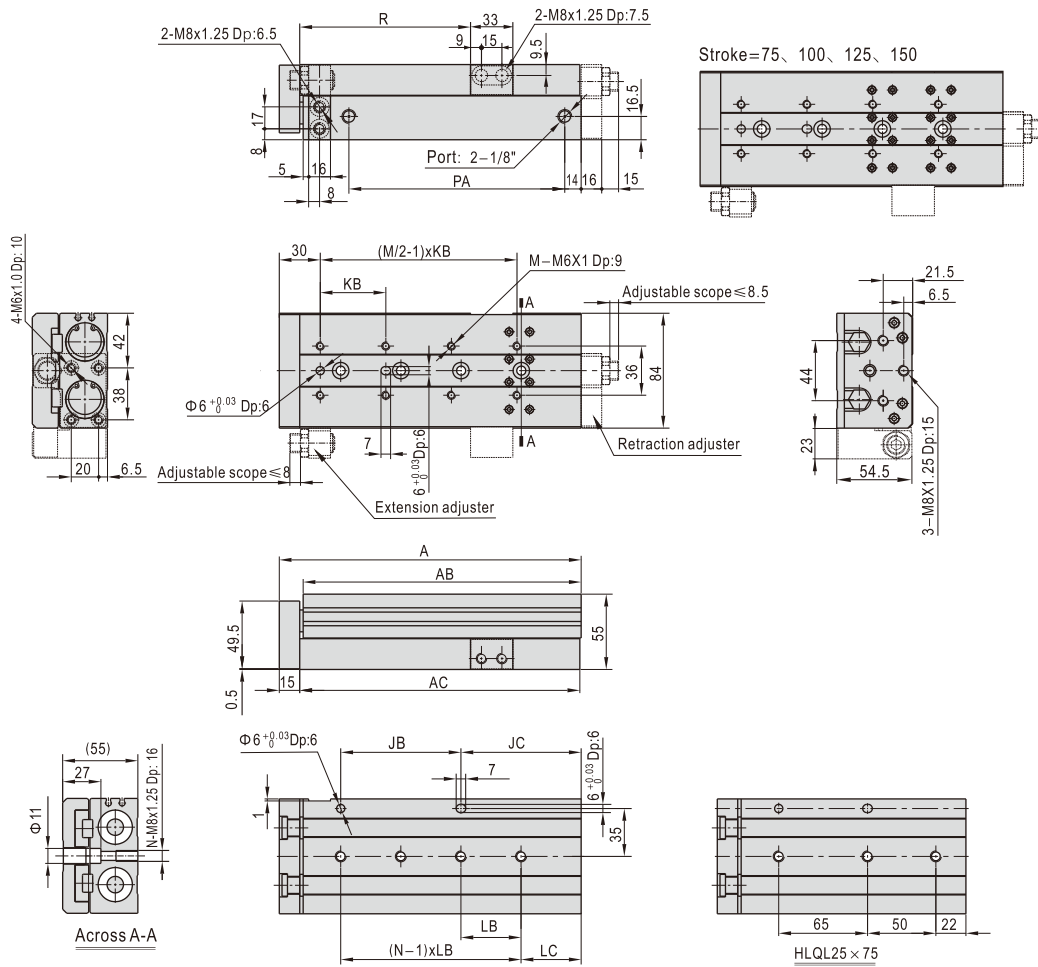

Stroke\Item	A	AB	AC	JB	JC	KB	LB	LC	M	N	PA	R
10	123	105.5	107	55	23	55	55	23	4	2	58	35
20	123	105.5	107	55	23	46	55	23	4	2	58	45
30	123	105.5	107	55	23	55	55	23	4	2	58	55
40	133	115.5	117	65	23	65	65	23	4	2	68	65
50	157	139.5	141	80	32	75	80	32	4	2	92	75
75	182	164.5	166	65	72	60	-	-	6	3	117	100
100	221	203.5	205	88	88	48	44	44	8	4	156	125
125	274	256.5	258	132	97	60	66	31	8	4	209	150
150	299	281.5	283	132	122	65	66	56	8	4	234	175

HLQL25(With shock absorber)

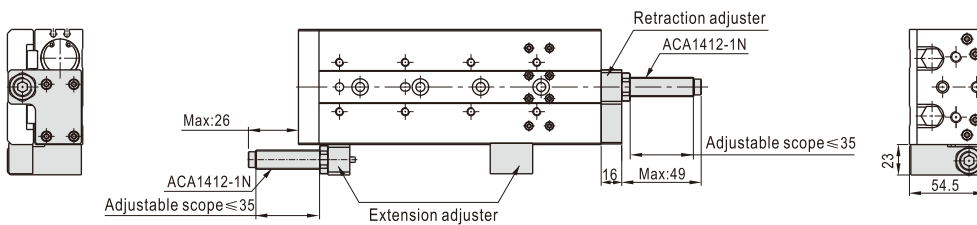

Compact slide cylinder(Recirculating linear ball bearing) **AIRTAC**

HLQ、HLQL Series—Accessories

Accessory selection

	Accessories\Bore size		6	8	12
	Standard (HLQ)	Both ends	A(Adjustable rubber stopper)	F-HLQ6A	F-HLQ8A
B(Shock absorber)			×	F-HLQ8B	F-HLQ12B
Extension		AS(Adjustable rubber stopper)	F-HLQ6AS	F-HLQ8AS	F-HLQ12AS
		BS(Shock absorber)	×	F-HLQ8BS	F-HLQ12BS
Retraction		AF(Adjustable rubber stopper)	F-HLQ6AF	F-HLQ8AF	F-HLQ12AF
		BF(Shock absorber)	×	F-HLQ8BF	F-HLQ12BF
	Accessories\Bore size		16	20	25
	Standard (HLQ)	Both ends	A(Adjustable rubber stopper)	F-HLQ16A	F-HLQ20A
B(Shock absorber)			F-HLQ16B	F-HLQ20B	F-HLQ25B
Extension		AS(Adjustable rubber stopper)	F-HLQ16AS	F-HLQ20AS	F-HLQ25AS
		BS(Shock absorber)	F-HLQ16BS	F-HLQ20BS	F-HLQ25BS
Retraction		AF(Adjustable rubber stopper)	F-HLQ16AF	F-HLQ20AF	F-HLQ25AF
		BF(Shock absorber)	F-HLQ16BF	F-HLQ20BF	F-HLQ25BF
	Accessories\Bore size		6	8	12
	Symmetrical (HLQL)	Both ends	A(Adjustable rubber stopper)	F-HLQL6A	F-HLQL8A
B(Shock absorber)			×	F-HLQL8B	F-HLQL12B
Extension		AS(Adjustable rubber stopper)	F-HLQL6AS	F-HLQL8AS	F-HLQL12AS
		BS(Shock absorber)	×	F-HLQL8BS	F-HLQL12BS
Retraction		AF(Adjustable rubber stopper)	F-HLQL6AF	F-HLQL8AF	F-HLQL12AF
		BF(Shock absorber)	×	F-HLQL8BF	F-HLQL12BF
	Accessories\Bore size		16	20	25
	Symmetrical (HLQL)	Both ends	A(Adjustable rubber stopper)	F-HLQL16A	F-HLQL20A
B(Shock absorber)			F-HLQL16B	F-HLQL20B	F-HLQL25B
Extension		AS(Adjustable rubber stopper)	F-HLQL16AS	F-HLQL20AS	F-HLQL25AS
		BS(Shock absorber)	F-HLQL16BS	F-HLQL20BS	F-HLQL25BS
Retraction		AF(Adjustable rubber stopper)	F-HLQL16AF	F-HLQL20AF	F-HLQL25AF
		BF(Shock absorber)	F-HLQL16BF	F-HLQL20BF	F-HLQL25BF

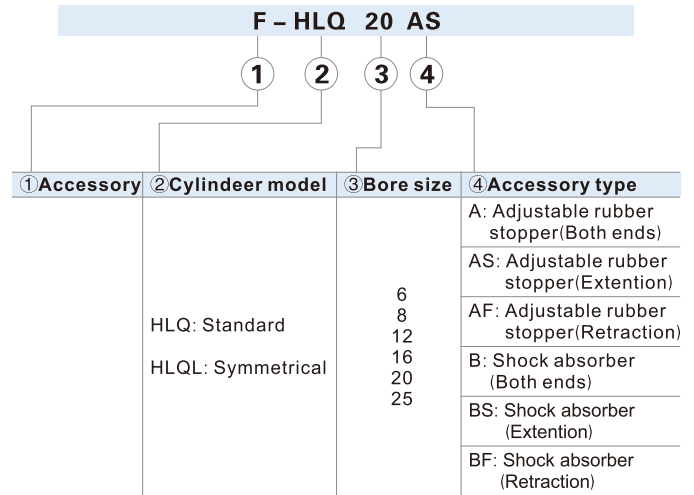

Note): A=AS+AF; B=BS+BF.

Dimensions

AS: Adjustable rubber stopper(Extension)

Body Mounting

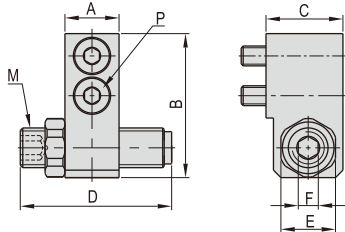
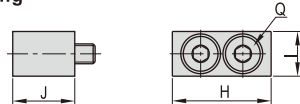

Table Mounting



Bore size\Item	Adjusting stroke range	A	B	C	D	E	F
6	5	7	19	10.5	16.5	8	3
8	5	8.5	21.5	14	21.5	11	4
12	5	11	29	15.5	31.5	11	4
16	5	12	36	17.5	24	14	5
20	5	15	44.5	22	28	17	6
25	5	16	53.5	24	32	19	6

Bore size\Item	M	P	H	I	J	Q
6	M6 × 1.0	M2.5Length:10	12.5	6.5	10.5	M2.5Length:10
8	M8 × 1.0	M3Length:14	14.5	8	12	M3Length:14
12	M8 × 1.0	M4Length:16	20	9	13.5	M4Length:12
16	M10 × 1.0	M5Length:16	23	10.5	17	M5Length:16
20	M12 × 1.0	M6Length:20	25	12.5	21	M6Length:20
25	M14 × 1.5	M8Length:20	33	16.5	23	M8Length:20

BS: Shock absorber(Extension)

Body Mounting

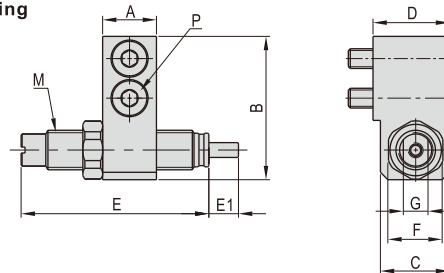
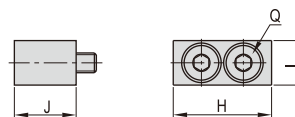

Table Mounting



Bore size\Item	A	B	C	D	E	E1	F	G	M	P	H	I	J	Q
8	8.5	21.5	12.5	14	40	6	11	7	M8 × 1.0	M3Length:14	14.5	8	12	M3Length:14
12	11	29	14	15.5	40	6	11	7	M8 × 1.0	M4Length:16	20	9	13.5	M4Length:12
16	12	36	16	17.5	49	7	14	9	M10 × 1.0	M5Length:16	23	10.5	17	M5Length:16
20	15	44.5	20	22	53.5	10	17	11	M12 × 1.0	M6Length:20	25	12.5	21	M6Length:20
25	16	53.5	22	24	68.5	12	19	12	M14 × 1.5	M8Length:20	33	16.5	23	M8Length:20

Compact slide cylinder(Recirculating linear ball bearing) **AIRTAC**

HLQ、HLQL Series—Accessories

AF: Adjustable rubber stopper(Retraction, for standard)

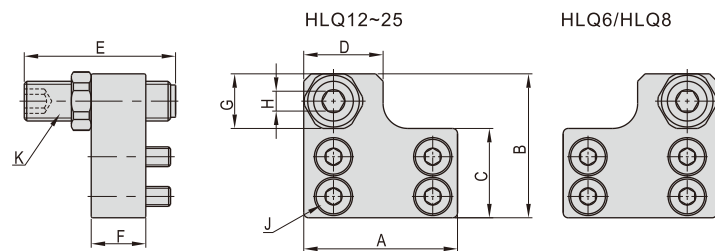

Bore size\Item	Adjusting stroke range	A	B	C	D	E	F	G	H	J	K
6	5	18	19	11	8	21.5	7	8	3	M2.5Length:6	M6 × 1.0
8	5	24	22	13	14	21.5	8.5	11	4	M3Length:8	M8 × 1.0
12	5	31	29	18	16	31.5	11	11	4	M4Length:12	M8 × 1.0
16	5	37	36	21.5	18	24	12	14	5	M5Length:12	M10 × 1.0
20	5	45.5	44	25.5	23	28	15	17	6	M5Length:16	M12 × 1.0
25	5	54	53.6	31.6	28	32	16	19	6	M6Length:18	M14 × 1.5

BF: Shock absorber(Retraction, for standard)

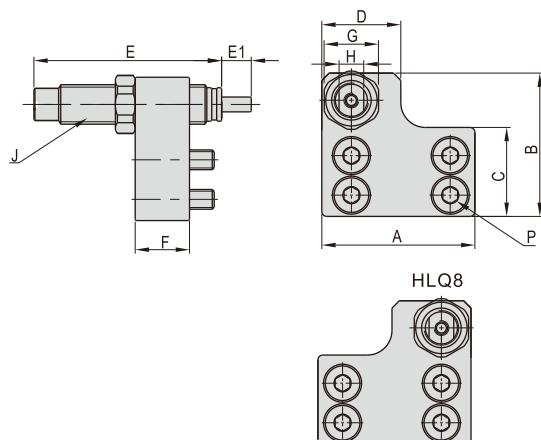

Bore size\Item	A	B	C	D	E	E1	F	G	H	J	P
8	24	22	13	14	40	6	8.5	11	7	M8 × 1.0	M3Length:8
12	31	29	18	16	40	6	11	11	7	M8 × 1.0	M4Length:12
16	37	36	21.5	18	49	7	12	14	9	M10 × 1.0	M5Length:12
20	45.5	44	25.5	23	53.5	10	15	17	11	M12 × 1.0	M5Length:16
25	54	53.6	31.6	28	68.5	12	16	19	12	M14 × 1.5	M6Length:18

AF: Adjustable rubber stopper(Retraction, for symmetrical)

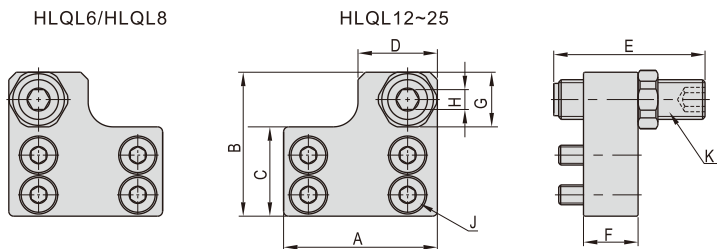

Bore size\Item	Adjusting stroke range	A	B	C	D	E	F	G	H	J	K
6	5	18	19	11	8	21.5	7	8	3	M2.5Length:6	M6 × 1.0
8	5	24	22	13	14	21.5	8.5	11	4	M3Length:8	M8 × 1.0
12	5	31	29	18	16	31.5	11	11	4	M4Length:12	M8 × 1.0
16	5	37	36	21.5	18	24	12	14	5	M5Length:12	M10 × 1.0
20	5	45.5	44	25.5	23	28	15	17	6	M5Length:16	M12 × 1.0
25	5	54	53.6	31.6	28	32	16	19	6	M6Length:18	M14 × 1.5

BF: Shock absorber(Retraction, for symmetrical)

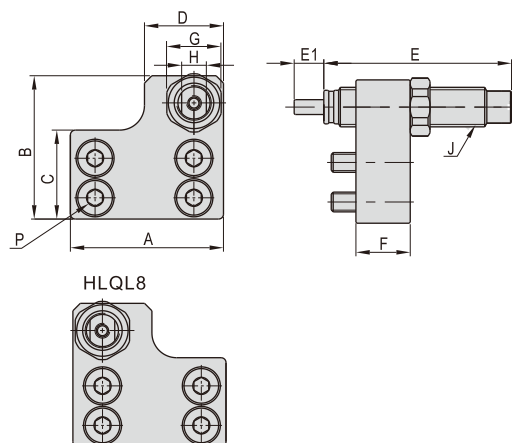

Bore size\Item	A	B	C	D	E	E1	F	G	H	J	P
8	24	22	13	14	40	6	8.5	11	7	M8 × 1.0	M3Length:8
12	31	29	18	16	40	6	11	11	7	M8 × 1.0	M4Length:12
16	37	36	21.5	18	49	7	12	14	9	M10 × 1.0	M5Length:12
20	45.5	44	25.5	23	53.5	10	15	17	11	M12 × 1.0	M5Length:16
25	54	53.6	31.6	28	68.5	12	16	19	12	M14 × 1.5	M6Length:18